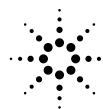
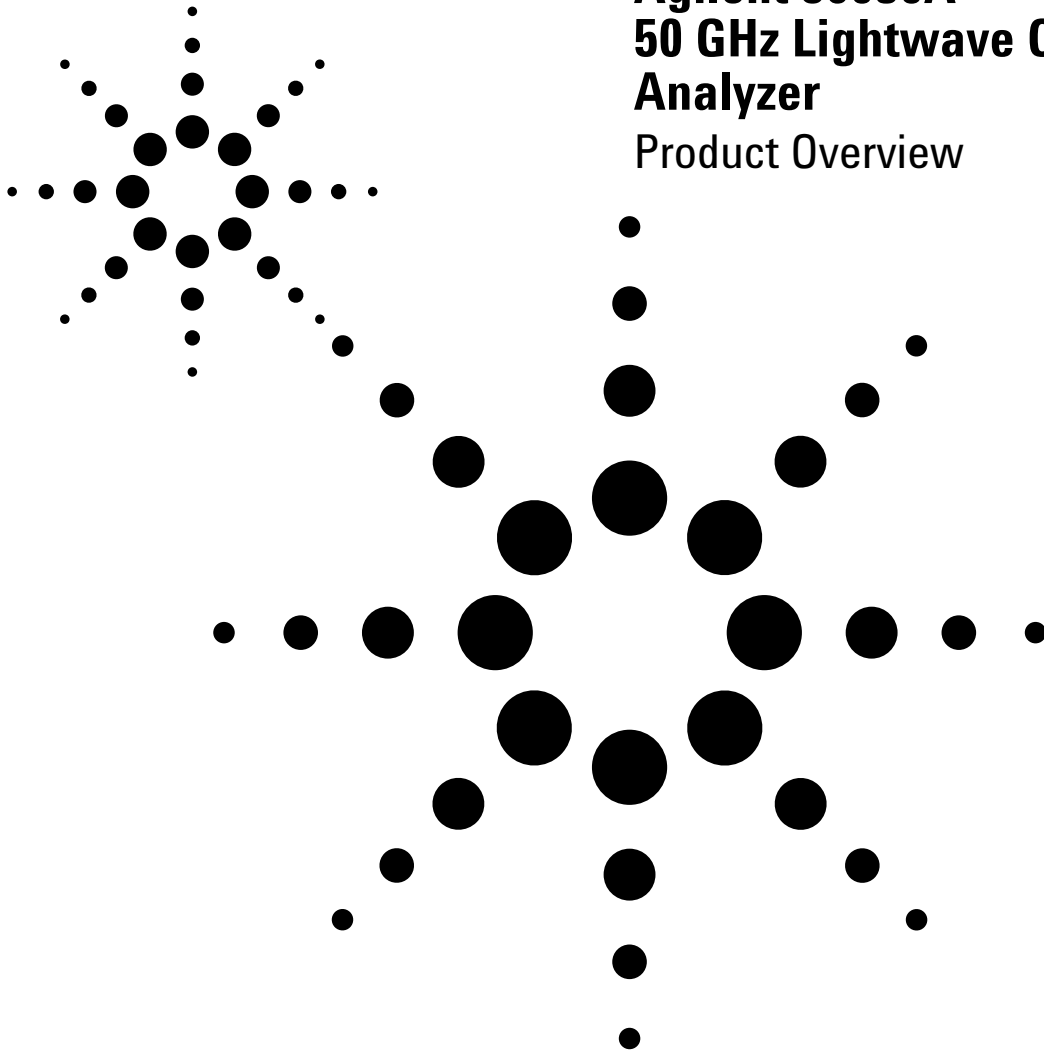


# Agilent 86030A 50 GHz Lightwave Component Analyzer

## Product Overview



**Agilent Technologies**

## Characterize 40 Gb/s optical components

Modern lightwave transmission systems require accurate and repeatable characterization of their optoelectronic, optical, and electrical components to guarantee high-speed performance. The Agilent 86030A 50 GHz lightwave component analyzer improves the design and specification of these lightwave components by accurately characterizing their bandwidth and reflection characteristics.

For manufacturers building 40 Gb/s electro-optical, optical, and electrical components used in high-speed OC-768 lightwave systems, the 86030A is necessary to completely characterize these components at modulation frequencies up to 50 GHz. Components such as photodiode receivers, lightwave modulators, and other optical and electrical components used in 40 Gb/s lightwave systems can be characterized in either an R&D or manufacturing environment with the 86030A. This system provides you with confidence in the devices you design and manufacture for high-speed lightwave systems.

### Electro-optical components

Often the limiting elements in a fiber-optic transmission system are the electro-optical components (e.g. photodiodes, and modulators) which convert the electrical information to optical or vice versa. With the 86030A, calibrated measurements of modulation band-width, responsivity, and modulation range of an individual transducer are possible.

### Optical components

Optical components such as fiber, connectors, splitters, couplers, and lenses make up much of a fiber-optic network. The 86030A measures the modulation bandwidth, insertion loss, group delay, and optical return loss of these components.

### Electrical components

Linear electrical components such as amplifiers, filters, and transmission lines are used in fiber-optic

systems, and require characterization to ensure optimal performance. Typical measurements are bandwidth, insertion loss or gain, impedance match, and group delay.

### Calibrated measurements

One of the key benefits of the 50 GHz lightwave component analyzer is its ability to perform calibrated measurements on optical components. The system contains an O/E receiver that has been factory calibrated in magnitude, and characterized in phase. The ability to make calibrated measurements assures accuracy, reliability, and confidence in the components being measured. Additionally, the laser source, optical modulator, and calibrated O/E receiver are temperature stabilized which also improves the accuracy and repeatability of the measurements.

### Unique features

Several unique features are utilized in the system to provide accurate measurements. A response and match calibration is available to remove the mismatch uncertainty associated with highly reflective O/E converters. Factory amplitude calibration of the system uses a NIST traceable laser heterodyne technique; a time consuming procedure which provides

the most accurate calibration. Factory phase characterization of the system uses a new optical impulse response technique to characterize the phase response of the internal O/E receiver. Additionally the laser source, optical modulator, and calibrated O/E receiver are temperature stabilized to improve the accuracy and repeatability of the measurements.

### Verification device

A verification device is included with the system. It consists of an Agilent 83440D photo detector and its associated amplitude and phase data. This verification device can be used at any time to verify the measurement integrity of your system. A guided verification routine is provided which measures the verification device, and displays a graph of its response versus acceptable tolerances (see Figure 1). The verification device can be used periodically to monitor system calibration, and indicate when the optical test set needs to be recalibrated. It can also be used to resolve uncertainty if unexpected results are obtained from a test device. This verification capability provides confidence in the measurement integrity of the system.

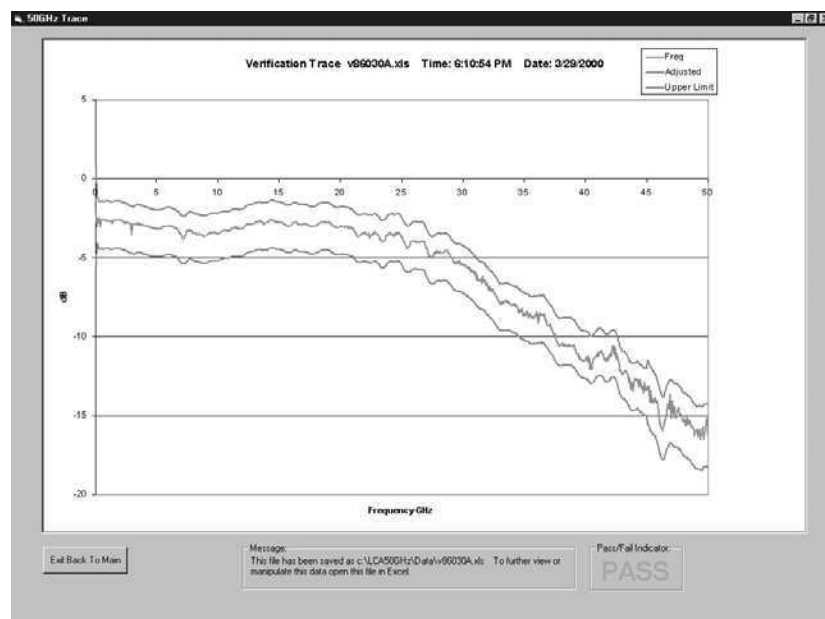


Figure 1. Typical verification device measured data, with tolerance limit lines.

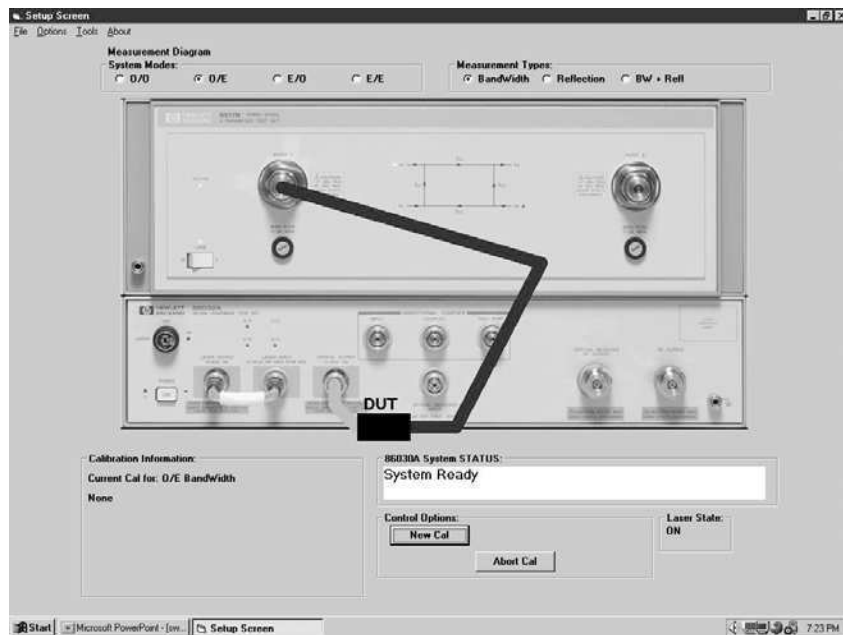


Figure 2. Typical guided measurement software screen for guided setup, calibration, and measurement.

### Guided measurement software

Guided measurement software that is part of the system, provides an easy-to-use operator interface (see Figure 2). It provides pictorial diagrams of inter-connections for configuration, calibration, and measurements. On-screen prompts also guide the operator through the entire measurement process, from the calibration to the measurement.

### Display, analysis, and archiving of data

Display, analysis, and archiving of data is easy and straightforward with the system. The measured data is displayed on the screen of the 8510C network analyzer (see Figure 3). Full use of the analyzer's functions such as markers, data formats, and data scaling features are available to the operator simply by pushing the appropriate keys on the network analyzer. Data can be archived to disk in either ASCII text or Microsoft® Excel formats. The included Excel software allows data to be displayed and analyzed using standard Excel features and formats (see Figure 4).

### Remote programmability for manufacturing test applications

For manufacturing test applications, it is often desirable to have a manu-

facturing test computer control the automated testing of your devices under test. This client computer may control many aspects of the testing operation in addition to controlling the 86030A lightwave component analyzer. The 86030A version B.01.08 system software contains a remote operation server and an application program interface that allows you to operate the 86030A remotely. This allows manufacturing test programmers to develop automated test programs, which can control the

86030A lightwave component analyzer. Remote programming for the 86030A is over a private LAN interface using standard Microsoft( Distributed Component Object Module (DCOM) interfaces and commands, which allow accessing the lightwave component analyzer application from a remote PC.

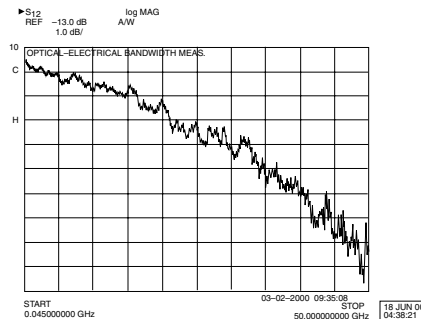


Figure 3. Typical data displayed on Agilent 8510C network analyzer.

### Accuracy and confidence in characterizing components

Modern lightwave transmission systems require accurate and repeatable characterizations of their electro-optical, optical, and electrical components to guarantee high-speed performance. The ability to make calibrated measurements with the 86030A ensures the accuracy of the measurements, while providing you with confidence in your device design, and device specifications.

Microsoft is a U.S. registered trademark of Microsoft Corporation.

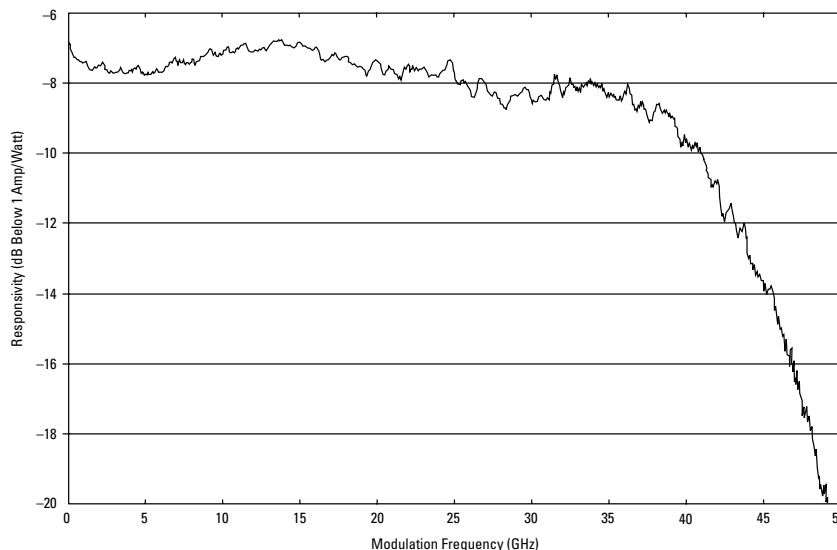


Figure 4. Typical measured data of an O/E converter displayed in Microsoft Excel format.

### System block diagram

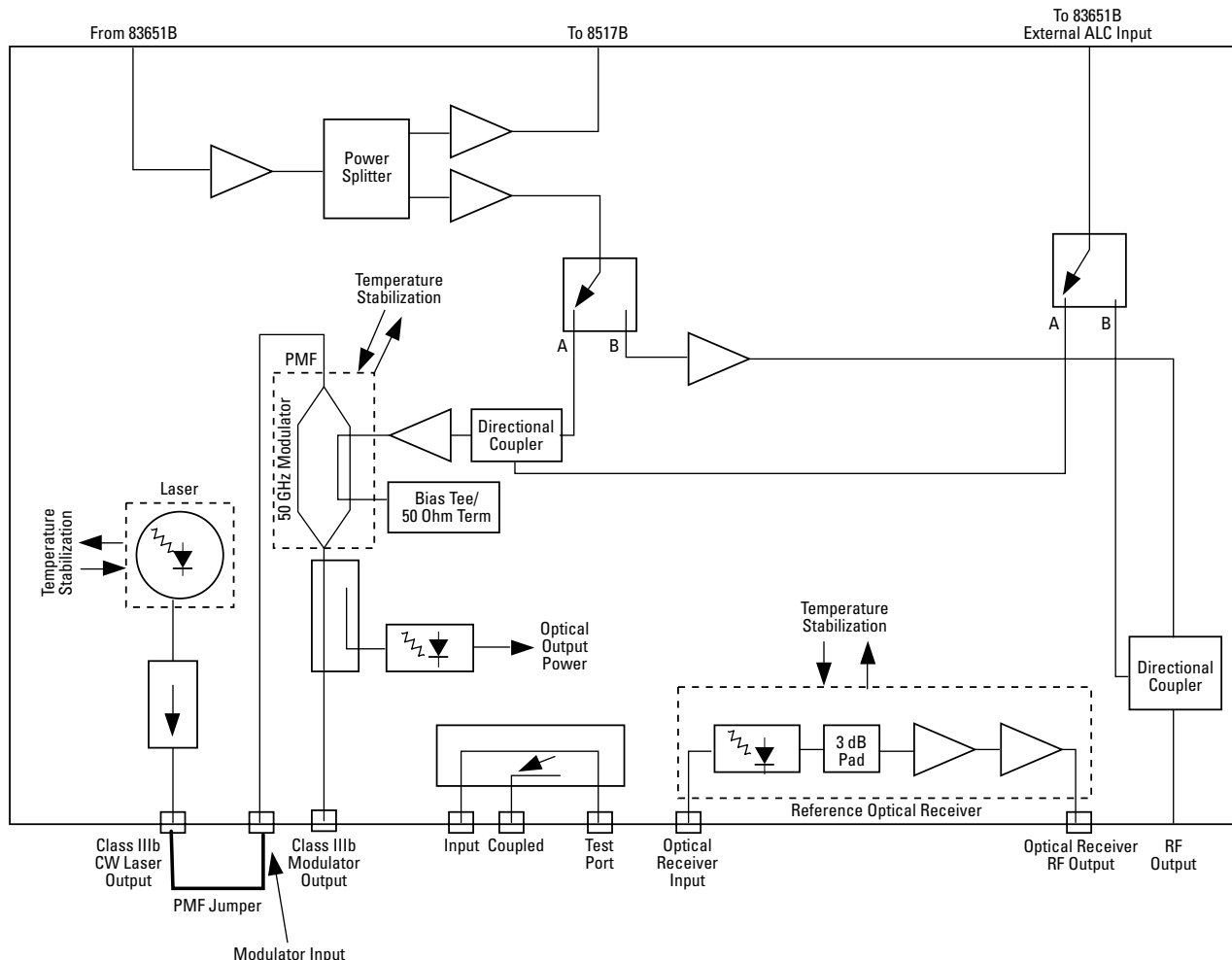
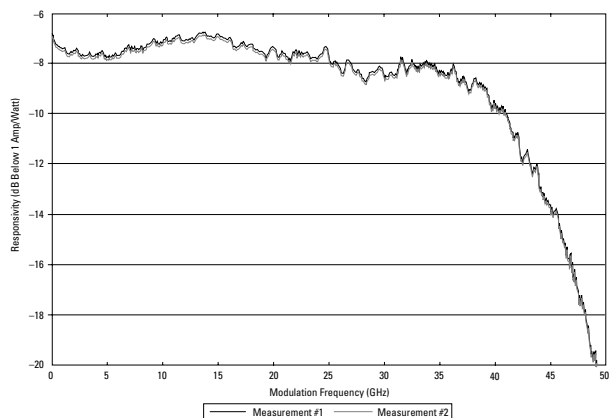


Figure 5. Simplified block diagram of lightwave test set.

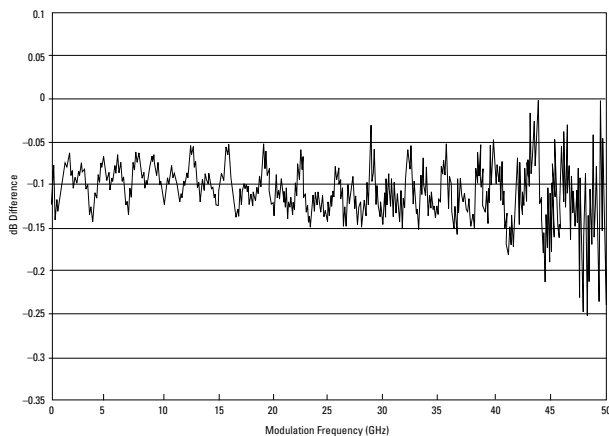
#### Typical Measurement Repeatability

For a measurement system to be useful when characterizing a device, it must provide repeatable measurements. The relative frequency response error limit specifications are quite large because the specifications must contain all the potential measurement uncertainties, plus an adequate guard band. Typical measurement repeatability values are much smaller. Figure 6 illustrates the short-term repeat-ability of the system. The same O/E device was measured two times with two user calibrations and two device connections. As can be seen from the plot, there is very little difference between the two measurements. Figure 7 shows the difference; there is about a 0.1 dB offset due to connector repeatability, and a  $\pm 0.05$  dB difference to 40 GHz, and a  $\pm 0.2$  dB difference from 40 to 50 GHz.



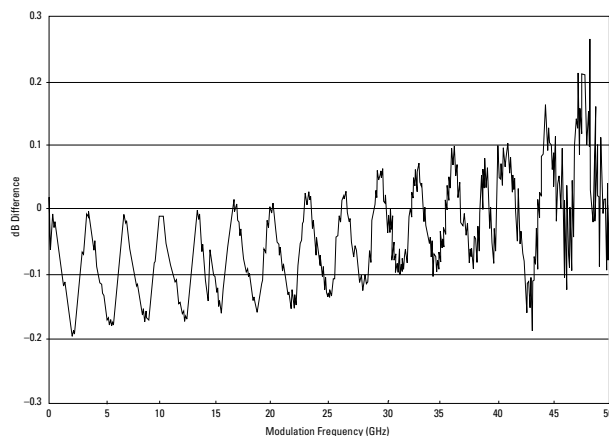


**Figure 6. Typical short-term measurement repeatability; the two traces overlay almost exactly.**



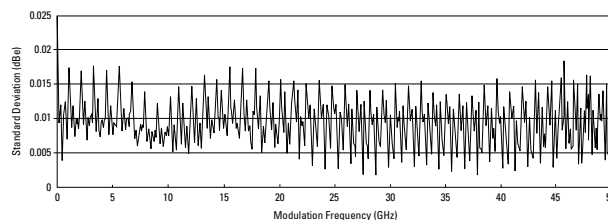
**Figure 7. Typical short-term repeatability difference.**

Typical long-term repeatability is illustrated in Figure 8. It shows the difference observed between two measurements taken 15 hours apart on an O/E device. No disconnection or recalibration was performed. It illustrates the typical errors that can be expected due to system drift.



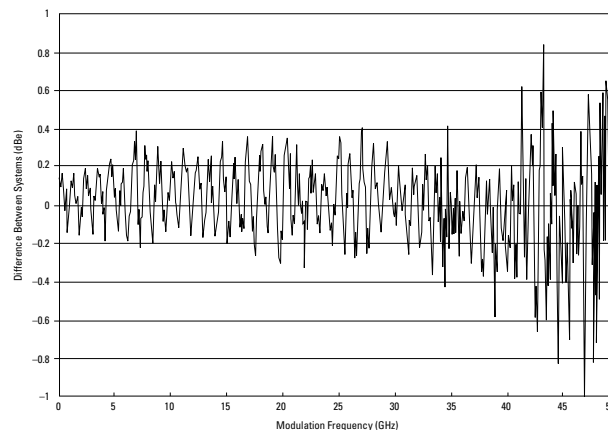
**Figure 8. Typical long-term repeatability.**

Typical sweep-to-sweep repeatability is illustrated in Figure 9. It shows the standard deviation between ten different swept traces.



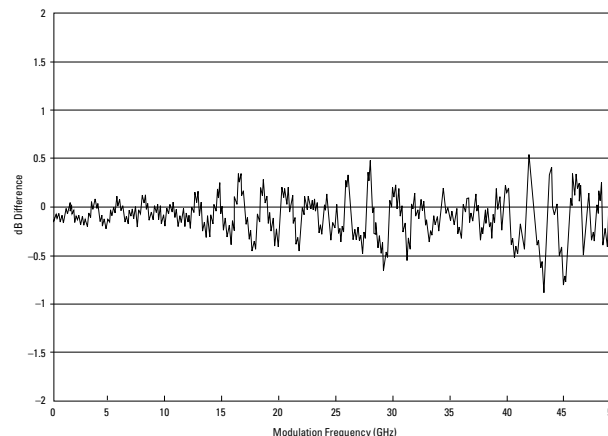
**Figure 9. Typical sweep-to-sweep repeatability.**

Typical system-to-system repeatability is illustrated in Figure 10. It shows the difference between two measurements of the same device measured on two different systems.



**Figure 10. Typical difference between two systems.**

Figure 11 illustrates the difference between an O/E device measured with an 86030A system, and a metrology calibration of the device using a NIST traceable heterodyne technique.



**Figure 11. Typical difference between metrology heterodyne measurement of an O/E device and the 86030A.**



## Specifications

### System Specifications

#### General Specifications

Parameter	Specification
<b>Specified temperature range</b>	20 °C to 30 °C
<b>Operating temperature range<sup>1</sup></b>	5 °C to 40 °C
<b>Storage temperature range</b>	-40 °C to +75 °C
<b>Power dissipation</b>	1940 VA max.
<b>Size</b>	1.6 x 0.6 x 0.9 meters

#### General Optical/Electrical Specifications

Parameter	Specification
<b>Modulation frequency range<sup>2</sup></b>	0.045 to 50 GHz
<b>Optical source center wavelength</b>	1550 to 1560 nm
<b>Optical output return loss<sup>3</sup></b>	> 30 dB
<b>Optical input return loss<sup>3</sup></b>	> 25 dB
<b>Average optical output power</b> (modulator set to minimum insertion loss) <sup>4</sup>	> 3 dBm
<b>Average optical output power</b> (modulator set at quadrature) <sup>5</sup>	> 0 dBm
<b>Average optical output power</b> (laser output port) <sup>6</sup>	> 8 dBm
<b>RF modulation power</b> (for E/O mode) <sup>7</sup>	
0.045–30 GHz	> 5 dBm
30–50 GHz	> 2.5 dBm
<b>Maximum operating optical input power</b> (to optical receiver input) <sup>8</sup>	Do not exceed 4 mW (6 dBm)
<b>Maximum optical input power to optical receiver</b> (without damage)	Do not exceed 15 mW (11.8 dBm)

### Optical to Electrical Measurement Mode Specifications

Relative frequency response concerns itself with the amount of error that accumulates when you compare the response of two or more frequency points. This would often be used in calculating the -3 dB roll-off point of an optical detector. The largest contribution to this error term is dependent on the reflectivity of the electrical port of the O/E device. Thus, relative frequency response is specified as a function of electrical port reflectivity. The electrical reflectivity of any O/E device can be measured using the E/E mode on the 86030A.

- <sup>1</sup> A user calibration is valid over a  $\pm 3.0^\circ\text{C}$  deviation from the initial user calibration temperature range.
- <sup>2</sup> Modulation frequency range is 0.045 to 50 GHz. System performance is not specified at modulation frequencies from 45 to 100 MHz. System specifications are for modulation frequencies from 0.100 to 50 GHz.
- <sup>3</sup> With factory new straight connectors. Improper connector care will degrade this specification.
- <sup>4</sup> With the modulator set to minimum insertion loss value. This specification is the default value set by the system software. Other power levels are settable from the system software.
- <sup>5</sup> With the modulator set at quadrature bias condition, which is the average of the minimum and maximum transmission state of the modulator. This specification indicates the default value set by the system software.
- <sup>6</sup> Other power levels are settable from the system software.
- <sup>7</sup> Power measured at the RF output port of the 86032A optical test set. System default power setting is 0 dBm. Other power levels are settable from the system software.

### O/E Relative Frequency Response Uncertainty<sup>9</sup>

Freq. range (GHz)	DUT reflection coefficient <sup>10</sup>		
	$\leq 0.25$	$\leq 0.5$	$\leq 1.0$
	<b>Specification (dBe)</b>	<b>Specification (dBe)</b>	<b>Specification (dBe)</b>
	<b>With/without attenuator</b>	<b>With/without attenuator</b>	<b>With/without attenuator</b>
<b>0.1 to 2</b>	$\pm 0.7/0.8$	$\pm 0.7/0.9$	$\pm 0.8/1.2$
<b>2 to 20</b>	$\pm 0.7/1.0$	$\pm 0.8/1.4$	$\pm 1.0/2.0$
<b>20 to 40</b>	$\pm 0.9/1.3$	$\pm 1.0/1.7$	$\pm 1.2/2.4$
<b>40 to 50</b>	$\pm 1.2/1.8$	$\pm 1.3/2.3$	$\pm 1.6/3.2$

For devices with highly reflective electrical ports, such as unterminated photodetectors, the resultant mismatch uncertainty contributes to high measurement uncertainty. Using an attenuator on the electrical port of the 8517B will reduce mismatch uncertainty, and thus reduce the total measurement uncertainty. The above specifications are shown with a 6 dB attenuator (supplied) on the electrical port of the 8517B, as well as without an attenuator.

The system has the ability to characterize the mismatch of the device under test, to reduce total measurement uncertainty. A response and match user calibration is used to reduce measurement uncertainty due to device mismatch. With this calibration, relative frequency response uncertainty is reduced, as shown in the following table.

### O/E Relative Frequency Response Uncertainty<sup>11</sup>

#### With response and match user calibration

Frequency range (GHz)	Specification (dBe) With response and match user calibration
<b>0.1 to 2</b>	$\pm 0.7$
<b>2 to 20</b>	$\pm 0.7$
<b>20 to 40</b>	$\pm 0.9$
<b>40 to 50</b>	$\pm 1.2$

- <sup>8</sup> Power in excess of this value will cause measurement inaccuracies.
- <sup>9</sup> This is the relative frequency response uncertainty (dBe). Specifications are shown with a 6 dB attenuator on the electrical port of the 8517B test set, as well as without an attenuator. Specification conditions: Response and isolation calibration, step mode of operation, 512 averages, factory default laser power setting, factory default optical modulation depth setting, and a signal-to-noise ratio greater than 20 dBe.
- <sup>10</sup> Device under test electrical port reflection coefficient. Specifications are shown for three different reflection coefficients.
- <sup>11</sup> Total relative frequency response uncertainty (dBe) which contains all of the uncertainty components. Specification conditions: Response and match calibration, step mode of operations, 512 averages, factory default laser power setting, factory default optical modulation depth setting, and a signal-to-noise ratio greater than 20 dBe.

**Absolute Noise Floor (O/E mode)**

Frequency Range (GHz)	Specification <sup>12</sup> (dBe)
0.1 to 0.2	-50
0.2 to 0.3	-60
0.3 to 0.5	-62
0.5 to 10	-70
10 to 20	-62
20 to 30	-56
30 to 40	-47
40 to 50	-42

**Absolute Responsivity Uncertainty**

Absolute responsivity uncertainty will be larger than the relative responsivity error, due to additional uncertainty contributed by the calibration transfer process, and the optical and electrical connector repeatability error.

**O/E Absolute Frequency Response Uncertainty<sup>13</sup> (A characteristic, not a specification)**

Frequency range (GHz)	DUT reflection coefficient <sup>14</sup>			With response & match user calibration (dBe) <sup>15</sup>
	≤ 0.25	≤ 0.5	≤ 1.0	
	With/without attenuator (dBe)	With/without attenuator (dBe)	With/without attenuator (dBe)	
0.1 to 2	±1.2/1.3	±1.2/1.4	±1.3/1.7	±1.2
2 to 20	±1.2/1.5	±1.3/1.9	±1.5/2.5	±1.2
20 to 40	±1.4/1.8	±1.5/2.2	±1.7/2.9	±1.4
40 to 50	±1.7/2.3	±1.8/2.8	±2.1/3.7	±1.7

<sup>12</sup> Absolute noise floor in O/E mode of operation. Units are dB electrical relative to 1 amp/watt. Specification conditions: Response and isolation calibration, step mode of operation, 512 averages, factory default laser power setting, factory default optical modulation depth setting, a signal-to-noise ratio greater than 20 dBe. This noise floor specification pertains to O/E converters with responsivity less than 1 amp/watt. O/E converters with large gain will cause the noise floor to rise.

<sup>13</sup> Specifications are shown with a 6 dB attenuator on the electrical port of the 8517B test set, as well as without an attenuator. Specification conditions: Response and isolation calibration, step mode of operation, 1024 averages, factory default laser power setting, factory default optical modulation depth setting, and a signal-to-noise ratio greater than 20 dBe.

<sup>14</sup> Device under test electrical port reflection coefficient. Specifications are shown for three different reflection coefficients.

<sup>15</sup> Total relative frequency response uncertainty (dBe) which contains all the uncertainty components. Specification conditions: Response and match calibration, step mode of operation, 512 averages, factory default laser power setting, factory default optical modulation depth setting, and a signal-to-noise ratio greater than 20 dBe.

## Electrical to Optical Measurement Mode Specifications

Relative frequency response concerns itself with the amount of error that accumulates when you compare the response of two or more frequency points. This would often be used in calculating the -3 dB roll-off point of a modulator. The largest contribution to this error term is dependent on the reflectivity of the electrical port of the E/O device. Thus, relative frequency response is specified as a function of electrical port reflectivity. The electrical reflectivity of any E/O device can be measured using the E/E mode on the 86030A.

### E/O Relative Frequency Response Uncertainty<sup>16</sup>

Frequency range (GHz)	Specification (dBe)	DUT reflection coefficient <sup>17</sup>	
		≤ 0.25	≤ 0.5
0.1 to 2	±0.6	±0.8	±1.3
2 to 20	±0.9	±1.3	±2.1
20 to 40	±1.0	±1.5	±2.5
40 to 50	±1.4	±2.1	±3.4

### Absolute Noise Floor (E/O mode)

Frequency Range (GHz)	Specification <sup>18</sup> (dBe)
0.1 to 0.2	-55
0.2 to 0.3	-57
0.3 to 0.5	-60
0.5 to 10	-61
10 to 20	-58
20 to 30	-55
30 to 40	-53
40 to 50	-50

<sup>16</sup> Total relative frequency response uncertainty (dBe) which contains all the uncertainty components. Specification conditions: Response and isolation calibration, 512 averages, factory default laser power setting, factory default optical modulation depth setting, and a signal-to-noise ratio greater than 20 dBe.

<sup>17</sup> Device under test electrical port reflection coefficient. Specifications are shown for three different reflection coefficients.

<sup>18</sup> Absolute noise floor in E/O mode of operation. Units are dB electrical relative to 1 watt/amp. Specification conditions: Response and isolation calibration, 512 averages, factory default laser power setting, factory default optical modulation depth setting, and a signal-to-noise ratio greater than 20 dBe.

<sup>19</sup> Device under test electrical port reflection coefficient. Specifications are shown for three different reflection coefficients.

<sup>20</sup> Optical noise floor is specified as dB below the 0 dBo loss reference. Specification conditions: Response and isolation calibration, 512 averages, factory default laser power settings, factory default modulation power setting, and a signal-to-noise ratio greater than 20 dBe.

### Absolute Responsivity Uncertainty (E/O mode)

Absolute responsivity uncertainty will be larger than the relative responsivity error, due to additional uncertainty contributions by the calibration transfer process, and the optical and electrical connector repeatability error.

### Absolute Responsivity Uncertainty (A characteristic, not a specification)

Frequency range (GHz)	DUT reflection coefficient <sup>19</sup>		
	≤ 0.25	≤ 0.5	≤ 1.0
0.1 to 2	±1.1	±1.3	±1.8
2 to 20	±1.4	±1.8	±2.6
20 to 40	±1.5	±2.0	±3.0
40 to 50	±1.9	±2.6	±3.9

## Optical to Optical Measurement Mode Specifications

### Optical Noise Floor

Frequency Range (GHz)	Specification <sup>20</sup> (dBo)
0.1 to 0.2	-24
0.2 to 0.3	-27
0.3 to 0.5	-30
0.5 to 10	-33
10 to 20	-30
20 to 30	-27
30 to 40	-22
40 to 50	-18

## Electrical to Electrical Measurement Mode Specifications

When configured as a lightwave component analyzer, the specifications for the E/E mode of operation is similar to the 85107B 50 GHz vector network analyzer, with the following exceptions. The user does not have control of the RF power applied to the 8517B test set, and the accuracy of the first points in a trace which are in the 45 MHz to 500 MHz range is significantly degraded. The full performance specifications of the 85107B, which are shown in this document, are obtained by reconnecting the 50 GHz 83651B source directly to the 8517B test set. These specifications are for a system calibrated with an 85056A 2.4 mm calibration kit using full two-port error correction (with sliding load) user calibration.

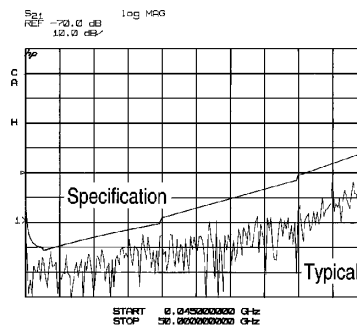


### Dynamic Range (for transmission measurements)

	Frequency Range (GHz)			
	0.045–0.84	0.84–20	20–40	40–50
<b>Maximum power</b> measured at port 2	+17 dBm	+8 dBm	+3 dBm	-4 dBm
<b>Reference power</b> at port 1 (nominal)	+2 dBm	-7 dBm	-17 dBm	-29 dBm
<b>Minimum power</b> measured at port 2	-75 dBm	-97 dBm	-91 dBm	-90 dBm
<b>Receiver dynamic range</b>	92 dB	105 dB	94 dB	86 dB
<b>System dynamic range</b>	77 dB	90 dB	74 dB	61 dB

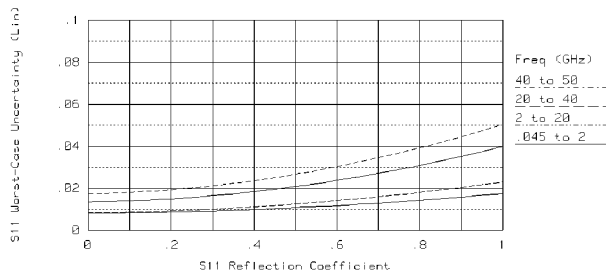
### Measurement Port Characteristics<sup>21</sup>

	Frequency range (GHz)			
	0.045–2	2–20	20–40	40–50
<b>Residual</b>				
<b>Directivity</b>	42 dB	42 dB	38 dB	36 dB
<b>Source match</b>	41 dB	38 dB	33 dB	31 dB
<b>Load match</b>	42 dB	42 dB	38 dB	36 dB
<b>Reflection tracking</b>	±0.001 dB	±0.008 dB	±0.02 dB	±0.027 dB
<b>Transmission tracking</b>	±0.014 dB	±0.043 dB	±0.110 dB	±0.137 dB
<b>Crosstalk</b>	99 dB	110 dB	93 dB	81 dB

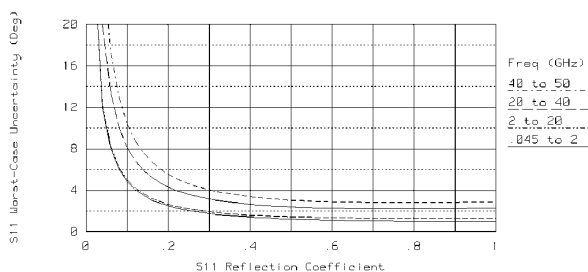


### Measurement uncertainty

#### Reflection measurements

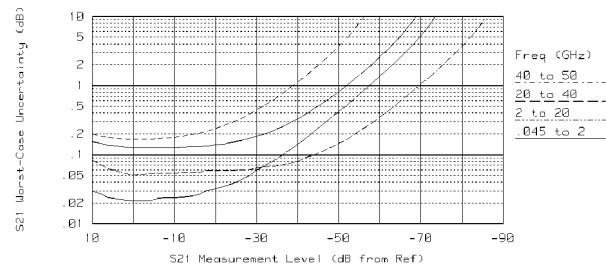


#### Receiver noise floor

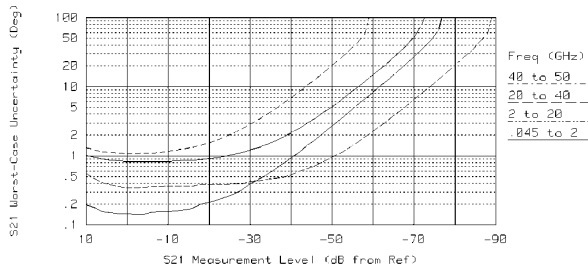


#### Magnitude

#### Transmission measurements



#### Phase



#### Magnitude

#### Phase

<sup>21</sup> After a user calibration with full 2-port error correction.

### Maximum Input Power to the 8517B Test Ports

The following maximum power levels into the 8517B test set ports should not be exceeded in order to avoid an IF overload condition in the receiver, which can cause a non-linear receiver error.

Frequency range (GHz)	Max power into 8517B test set (dBm)
0.045 to 2	+18
2 to 20	+8
20 to 40	+4
40 to 50	-3

### Typical Optical Modulation Power

This table shows the typical optical modulation power available from the output of the laser modulator with factory default settings.

Frequency range (GHz)	Typical optical modulation power (dBm)
0.045 to 0.84	0
0.84 to 20	-3
20 to 40	-5
40 to 50	-10

### Optical Test Set Typical Characteristics

The system has the ability to monitor input and output power levels.

**Laser power setting accuracy:**

±0.5 dB over the 0 to 10 dBm range.

**Output power monitor accuracy:**

±0.5 dB over the -10 to 5 dBm range.

**Input power monitor accuracy:**

±0.5 dB over the -10 to 5 dBm range.

### Configuration Options

**86030A-120:** 110-130 volt a.c. power operation

**86030A-230:** 220-240 volt a.c. power operation

**86030A-011:** Diamond HMS-10 optical connector interface

**86030A-012:** FC/PC optical connector interface

**86030A-013:** DIN 47256 optical connector interface

**86030A-014:** ST optical connector interface

**86030A-017:** SC optical connector interface

### Ordering Information

For more information, or to order a system, contact your local sales engineer.



#### Agilent Email Updates

[www.agilent.com/find/emailupdates](http://www.agilent.com/find/emailupdates)

Get the latest information on the products and applications you select.

## **Agilent Technologies' Test and Measurement Support, Services, and Assistance**

Agilent Technologies aims to maximize the value you receive, while minimizing your risk and problems. We strive to ensure that you get the test and measurement capabilities you paid for and obtain the support you need. Our extensive support resources and services can help you choose the right Agilent products for your applications and apply them successfully. Every instrument and system we sell has a global warranty. Support is available for at least five years beyond the production life of the product. Two concepts underlie Agilent's overall support policy: "Our Promise" and "Your Advantage."

### **Our Promise**

Our Promise means your Agilent test and measurement equipment will meet its advertised performance and functionality. When you are choosing new equipment, we will help you with product information, including realistic performance specifications and practical recommendations from experienced test engineers. When you use Agilent equipment, we can verify that it works properly, help with product operation, and provide basic measurement assistance for the use of specified capabilities, at no extra cost upon request. Many self-help tools are available.

### **Your Advantage**

Your Advantage means that Agilent offers a wide range of additional expert test and measurement services, which you can purchase according to your unique technical and business needs. Solve problems efficiently and gain a competitive edge by contracting with us for calibration, extra-cost upgrades, out-of-warranty repairs, and on-site education and training, as well as design, system integration, project management, and other professional engineering services. Experienced Agilent engineers and technicians worldwide can help you maximize your productivity, optimize the return on investment of your Agilent instruments and systems, and obtain dependable measurement accuracy for the life of those products.

**By internet, phone, or fax, get assistance with all your test & measurement needs.**

### **Online assistance:**

**[www.agilent.com/comms/lightwave](http://www.agilent.com/comms/lightwave)**

### **Phone or Fax**

#### **United States:**

(tel) 1 800 452 4844

#### **Canada:**

(tel) 1 877 894 4414

(fax) (905) 282 6495

#### **China:**

(tel) 800-810-0189

(fax) 1-0800-650-0121

#### **Europe:**

(tel) (31 20) 547 2323

(fax) (31 20) 547 2390

#### **Japan:**

(tel) (81) 426 56 7832

(fax) (81) 426 56 7840

#### **Korea:**

(tel) (82-2) 2004-5004

(fax)(82-2) 2004-5115

#### **Latin America:**

(tel) (305) 269 7500

(fax) (305) 269 7599

#### **Taiwan:**

(tel) 080-004-7866

(fax) (886-2) 2545-6723

#### **Other Asia Pacific Countries:**

(tel) (65) 375-8100

(fax) (65) 836-0252

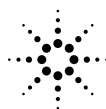
Email: [tm\\_asia@agilent.com](mailto:tm_asia@agilent.com)

Product specifications and descriptions in this document subject to change without notice.

© 2000, 2002 Agilent Technologies, Inc.

Printed in USA September 27, 2002

5968-9734E



**Agilent Technologies**